

Size 5 Bayonet Recuperator

Model BR5

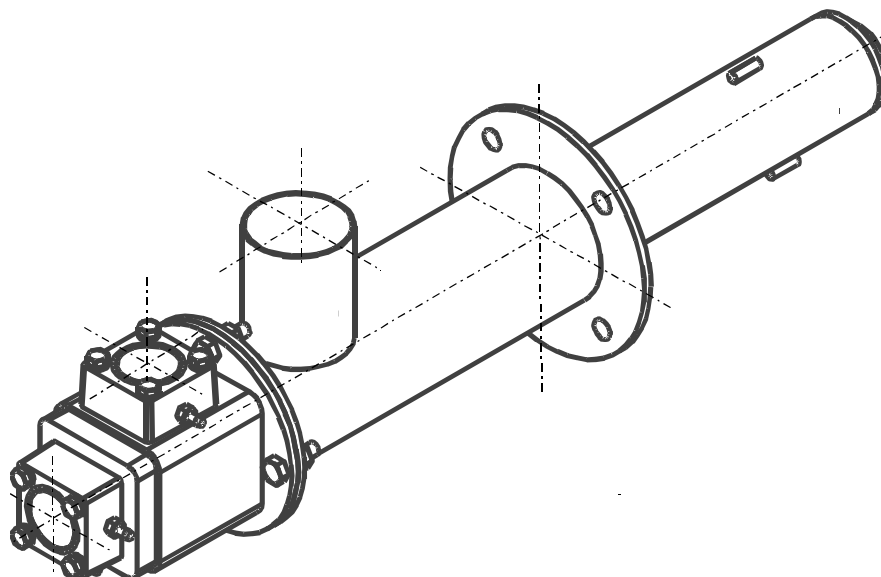

Main Specifications	
Minimum Inside Diameter of Radiant Tube	5" (125mm)
Maximum Exhaust Temperature	2100 °F (1090 °C)
Maximum Capacity <i>based on 6" w.c. drop through recuperator and 4.5" w.c. drop over the metering orifice plate, 10.5" w.c. total. Higher capacity can be accommodated with higher pressure drop)</i>	200,000 BTU/hr
Mounting to Radiant Tube	Flanged or Slipover
Exhaust Outlet	Flanged or Plain
Air Connections	NPT or Metric
Air Outlet Position	Variable at 90° increments
Recuperator Length	300 to 600mm
Exhaust center line to mounting	100 to 300mm
Air Flow Measurement	Integral Air Orifice
Designed for use with Eclipse TFB burners, refer to Design Guide 310	
Exhaust Eductor available for negative pressure requirements	

- All information is based upon laboratory testing.
- All inputs are based upon gross caloric values.
- Eclipse reserves the right to change the construction and/or configuration of our products at any time without being obliged to adjust earlier supplies accordingly.
- All pressure drops are based on 15% excess combustion air.



Eclipse Combustion

ISO 9001 Registered

Performance Graphs BR5

Pre-Heat Air Temperature vs. Input/Exhaust Temperature

(Based on 500mm Effective Length)

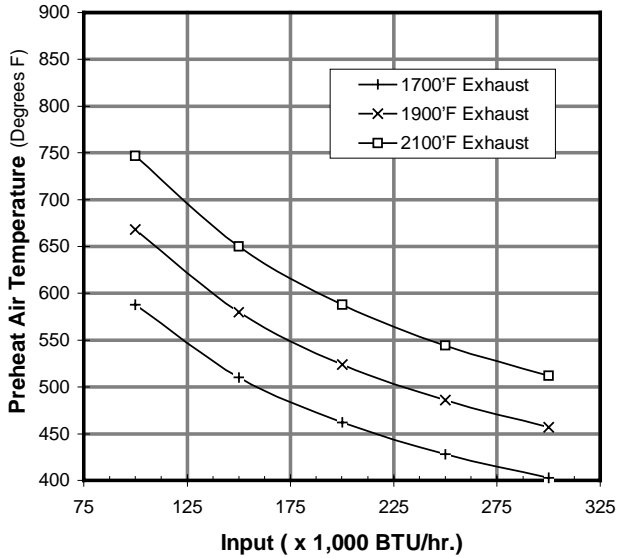

Combustion Air and Exhaust Pressure Drop vs. Input

(Based on 500mm Effective Length & 1900 F Exhaust)

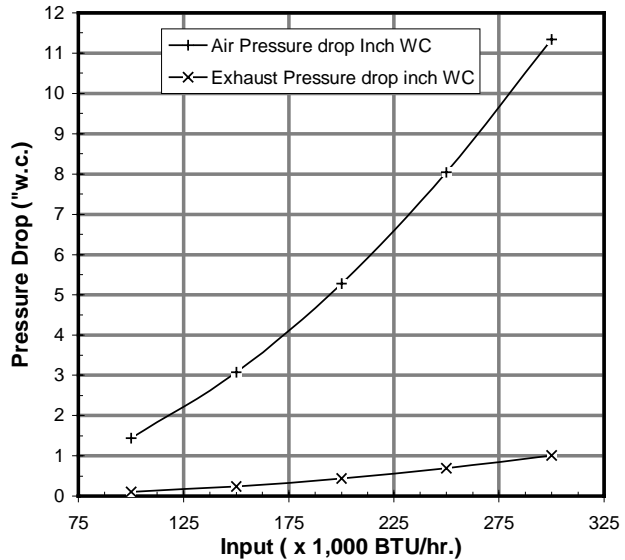

Note: Air and exhaust pressure drops are provided for system sizing only. This information is not intended for system set-up.

Pre-Heat Air Temperature vs. Input/Exhaust Temperature

(Based on 600mm Effective Length)

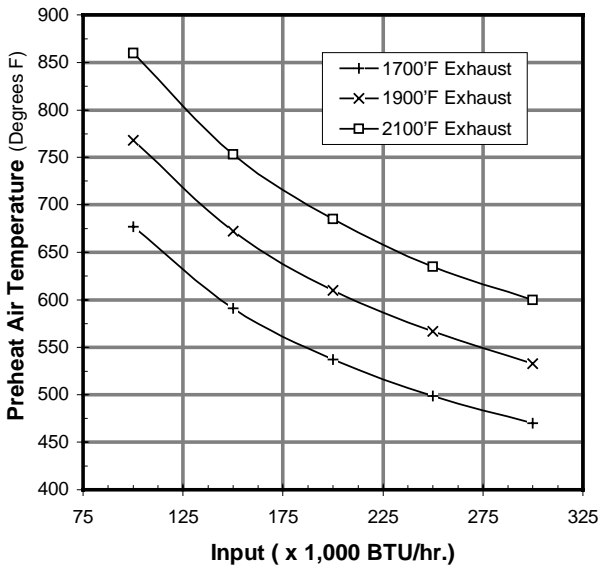

Combustion Air and Exhaust Pressure Drops vs. Input

(Based on 600mm Effective Length & 1900 F Exhaust)

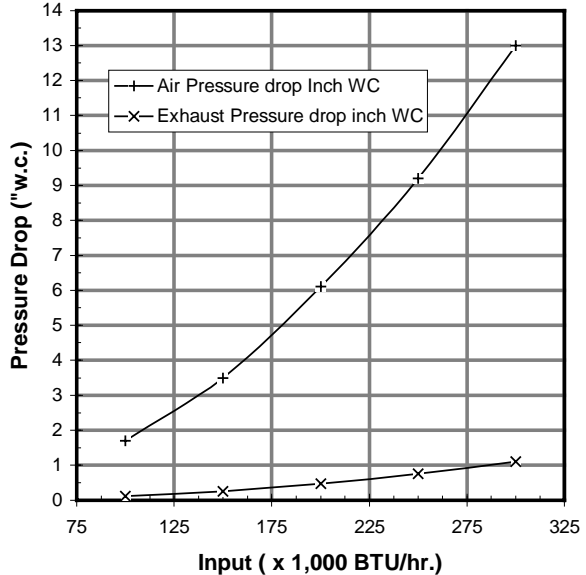

Dimensions BR5

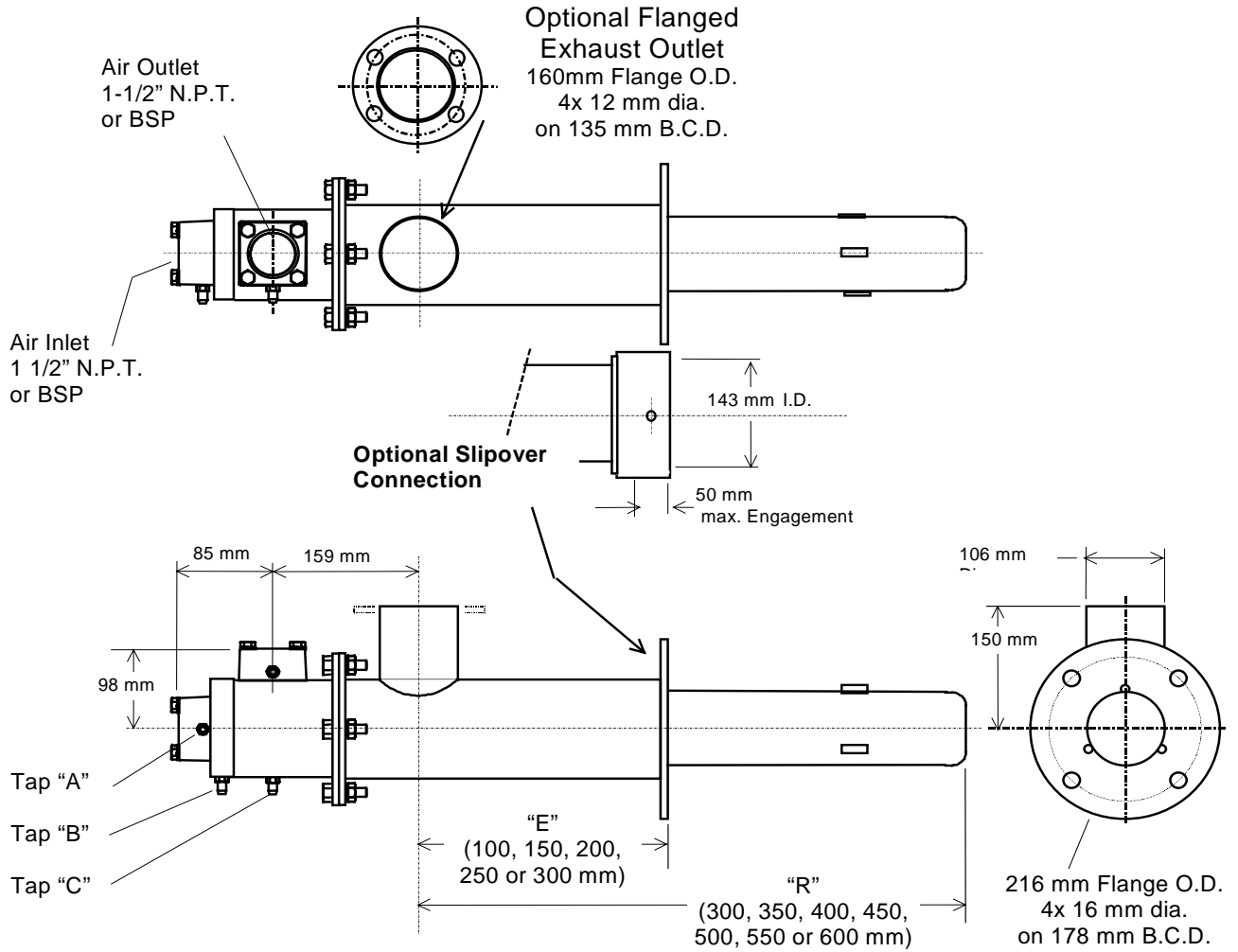

Combustion Air Orifice Pressure Drop vs. Input

(Tap "A" to "B" with 29mm dia orifice)

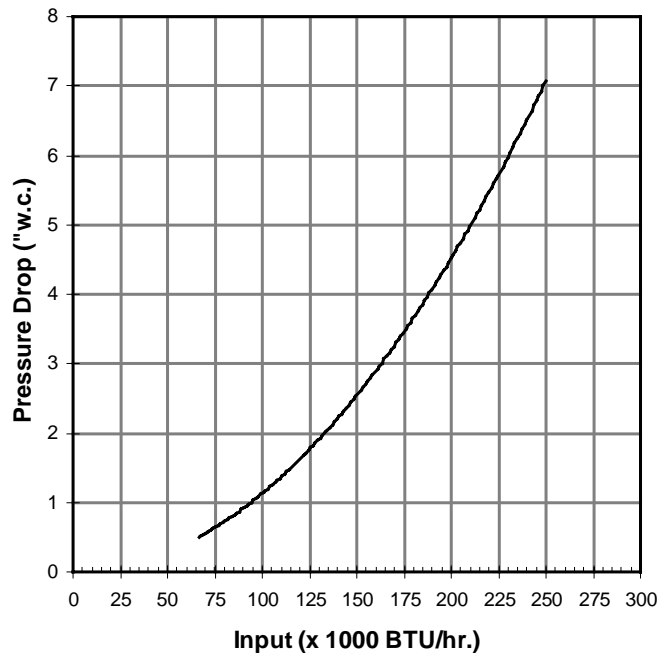



Offered By:

Power Equipment Company
2011 Williamsburg Road
Richmond, Virginia 23231
Phone (804) 236-3800
Fax (804) 236-3882

www.peconet.com